



## Bainwat



[NL]

Dankzij de champagnevormige opalen glaasjes zorgt deze schitterende collectie van badkamerverlichting voor een goed verdeeld diffuus licht. Deze verlichting maakt de Bainwat-collectie ideaal om naast of boven spiegels te hangen. De smalle, glazen kapjes verbergen de dieperliggende lichtbron. Daardoor is verblinding haast uitgesloten, maar tegelijk werpt deze verlichting een goed verdeeld licht op het gelaat en de omgeving. De Bainwat-collectie heeft een ietwat Engelse landelijke sfeer. Het chroom, dat vaak wordt gekozen, sluit het best aan bij het in badkamers veel voorkomende kraanwerk.

[FR]

*Grâce à son verre opalin en forme de verre de champagne, cette belle collection de luminaires de salle de bain procure une lumière diffuse bien répartie. Son éclairage rend la collection Bainwat idéale pour être placée à côté ou au-dessus des miroirs. Les fines nuances du verre masquent l'origine de la lumière. L'éblouissement est ainsi pratiquement impossible et cet éclairage diffuse une bonne lumière bien répartie sur le visage et l'environnement. La Collection Bainwat a quelque chose du style anglais rural. Le chrome, qui est souvent choisi, convient le mieux pour l'équipement des salles de bains.*

[EN]

The champagne-glass shape of these opaque glasses gives this beautiful collection of bathroom lighting an evenly spread diffused light. This lighting makes the Bainwat collection ideal to hang alongside or above mirrors. The narrow, glass shades hide the underlying light source. Thus glare is almost impossible, but at the same time this lighting spreads light evenly on your face and on the surroundings. The Bainwat collection has a somewhat English country feel. Chrome, the most popular choice, matches perfectly the taps used in many bathrooms.

[DE]

*Dank den champagnerförmigen Opalgläsern sorgt diese prächtige Badezimmerbeleuchtungs-Kollektion für ein gut verteiltes diffuses Licht. Dieses Licht sorgt dafür, dass die Bainwat-Kollektion neben oder über Spiegeln ideal ist. Die schmalen Glaskappen verbergen die tieferliegende Lichtquelle. Dadurch ist Blendung quasi ausgeschlossen, aber wirft die Beleuchtung ein gut verteiltes Licht auf das Gesicht und die Umgebung. Die Bainwat-Kollektion bietet eine etwas englische ländliche Atmosphäre. Der häufig gewählte Chrom passt am besten zu den Armaturen des Badezimmers.*





# Bainwat Mignon

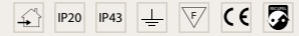

NEW

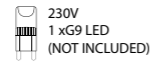
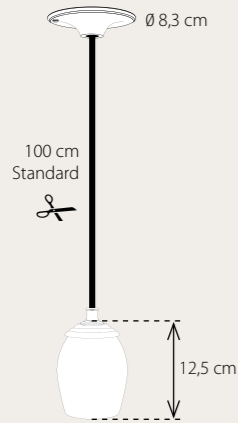

230V  
1 x G9 LED  
(NOT INCLUDED)  
A  
AMB 7/10 Fct 7

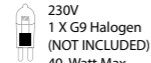

230V  
1 X G9 Halogen  
(NOT INCLUDED)  
40 Watt Max  
E  
AMB 7/10 Fct 8

## Bainwat Mignon Suspension IP 20

- BNW001MS2 Bronze
- BNW101MS2 Brushed Nickel
- BNW201MS2 Chrome

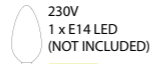
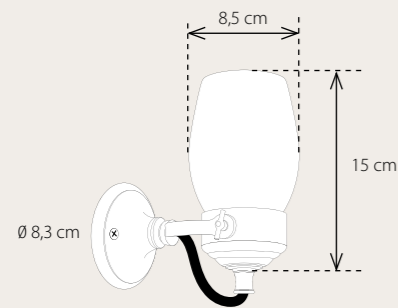

230V  
1 x E14 LED  
(NOT INCLUDED)  
A  
AMB 7/10 Fct 7  
NOT IP 43

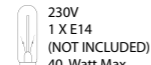

230V  
1 X E14  
(NOT INCLUDED)  
40 Watt Max  
E  
AMB 7/10 Fct 8

## Bainwat Mignon Wall IP 20

- BNW001MW2 Bronze
- BNW101MW2 Brushed Nickel
- BNW201MW2 Chrome

## Bainwat Mignon Wall IP 43



- BNW001MW4 Bronze
- BNW101MW4 Brushed Nickel
- BNW201MW4 Chrome

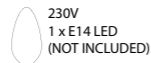
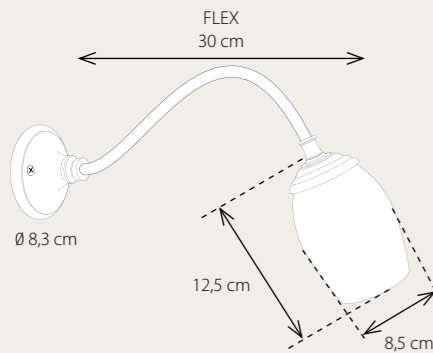

230V  
1 x E14 LED  
(NOT INCLUDED)  
A  
AMB 7/10 Fct 7  
NOT IP 43

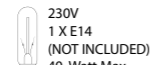

230V  
1 X E14  
(NOT INCLUDED)  
40 Watt Max  
E  
AMB 7/10 Fct 8

## Bainwat Mignon Flex IP 20

- BNW001MF2 Bronze
- BNW101MF2 Brushed Nickel
- BNW201MF2 Chrome

## Bainwat Mignon Flex IP 43



- BNW001MF4 Bronze
- BNW101MF4 Brushed Nickel
- BNW201MF4 Chrome



Bainwat Mignon Wall IP 20 Bronze



### Bainwat With Gooseneck

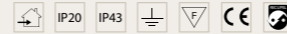

	<p>W = 8 cm</p> <p>Ø 8 cm</p> <p>20 cm</p>	<p>230V 1 x E14 LED (NOT INCLUDED)</p> <p>A</p> <p>AMB 7/10 Fct 7</p> <p><b>NOT IP 43</b></p>	<p><b>IP 20</b></p> <p>BNW001G70 Bronze</p> <p>BNW101G70 Brushed Nickel</p> <p>BNW201G70 Chrome</p> <p>BNWGLA510 Glass Bainwat</p>
			<p>230V 1 x E14 (NOT INCLUDED)</p> <p>40 Watt Max</p> <p>E</p> <p>AMB 7/10 Fct 8</p>

### Bainwat 90° Arm

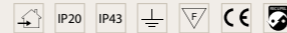

	<p>Ø 8 cm W = 8 cm</p> <p>17 cm</p>	<p>230V 1 x E14 LED (NOT INCLUDED)</p> <p>A</p> <p>AMB 7/10 Fct 7</p> <p><b>NOT IP 43</b></p>	<p><b>IP 20</b></p> <p>BNW001S70 Bronze</p> <p>BNW101S70 Brushed Nickel</p> <p>BNW201S70 Chrome</p> <p>BNWGLA510 Glass Bainwat</p>
			<p>230V 1 x E14 (NOT INCLUDED)</p> <p>40 Watt Max</p> <p>E</p> <p>AMB 7/10 Fct 8</p>

### Bainwat With double 90° Arm

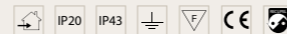

	<p>Ø 8 cm W = 8 cm</p> <p>17 cm</p>	<p>230V 2 x E14 LED (NOT INCLUDED)</p> <p>A</p> <p>AMB 7/10 Fct 7</p> <p><b>NOT IP 43</b></p>	<p><b>IP 20</b></p> <p>BNW002D70 Bronze</p> <p>BNW102D70 Brushed Nickel</p> <p>BNW202D70 Chrome</p> <p>BNWGLA510 Glass Bainwat</p>
			<p>230V 2 x E14 (NOT INCLUDED)</p> <p>40 Watt Max</p> <p>E</p> <p>AMB 7/10 Fct 8</p>

### Bainwat Plafonnier 14

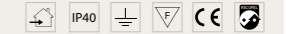

	<p>14 cm</p> <p>18 cm</p>	<p>230V 1 x E27 (NOT INCLUDED)</p> <p>Max 25 Watt</p> <p>E</p> <p>AMB 7/10 Fct 6</p>	<p>BNW001P14 Bronze</p> <p>BNW101P14 Brushed Nickel</p> <p>BNW201P14 Chrome</p> <p>BNWGLA514 Glass Bainwat 14</p>
			<p>230V 1 x E27 LED (NOT INCLUDED)</p> <p>A+</p> <p>AMB 6/10 Fct 7</p>

### Bainwat Plafonnier 21 / 25 / 30

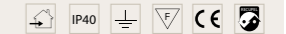

	<p>21 cm</p> <p>12,5 cm</p>	<p>230V 1 x E27 (NOT INCLUDED)</p> <p>Max 40 Watt</p> <p>E</p> <p>AMB 7/10 Fct 7</p>	<p><b>Bainwat Plafonnier 21</b></p> <p>BNW001P21 Bronze</p> <p>BNW101P21 Brushed Nickel</p> <p>BNW201P21 Chrome</p> <p>BNWGLA521 Glass Bainwat 21</p>
			<p>230V 1 x E27 LED (NOT INCLUDED)</p> <p>A+</p> <p>AMB 6/10 Fct 8</p>
	<p>25 cm</p> <p>16 cm</p>	<p>230V 1 x E27 (NOT INCLUDED)</p> <p>Max 60 Watt</p> <p>E</p> <p>AMB 7/10 Fct 8</p>	<p><b>Bainwat Plafonnier 25</b></p> <p>BNW001P25 Bronze</p> <p>BNW101P25 Brushed Nickel</p> <p>BNW201P25 Chrome</p> <p>BNWGLA525 Glass Bainwat 25</p>
			<p>230V 1 x E27 LED (NOT INCLUDED)</p> <p>A+</p> <p>AMB 6/10 Fct 9</p>
	<p>30 cm</p> <p>16 cm</p>	<p>230V 2 x E27 (NOT INCLUDED)</p> <p>Max 2 X 40 Watt</p> <p>E</p> <p>AMB 7/10 Fct 9</p>	<p><b>Bainwat Plafonnier 30</b></p> <p>BNW001P30 Bronze</p> <p>BNW101P30 Brushed Nickel</p> <p>BNW201P30 Chrome</p> <p>BNWGLA530 Glass Bainwat 30</p>
			<p>230V 2 x E27 LED (NOT INCLUDED)</p> <p>A+</p> <p>AMB 6/10 Fct 9</p>

\*For suitable lamps, see pages 433 to 445

